

DATASHEET

Product Name High-Precision Anti-Surge Thick Film Chip Resistors

Part Name PS Series

File No. SMD-SP-007

Uniroyal Electronics Global Co., Ltd.

88#, Longteng Road, Economic & Technical Development Zone, Kunshan, Jiangsu, China

Tel +86 512 5763 1411 / 22 /33

Email marketing@uni-royal.cn

Manufacture Plant Uniroyal Electronics Industry Co., Ltd.

Aeon Technology Corporation

Royal Electronic Factory (Thailand) Co., Ltd.

Royal Technology (Thailand) Co., Ltd.

1. Scope

- 1.1 This datasheet is the characteristics of High-Precision Anti-Surge Thick Film Chip Resistors manufactured by UNI-ROYAL.
- 1.2 Suitable for reflow & wave soldering
- 1.3 Application monitors, power supplies, DVD, camcorder, laptop computer
- 1.4 AEC-Q200 qualified
- 1.5 Compliant with RoHS directive.
- 1.6 Halogen free requirement.

2. Part No. System

Part No. includes 14 codes shown as below:

2.1 1st~4th codes: Part name. E.g.: PS02、PS03、PS05、PS06、PS07、PS10、PS12

2.2 5th~6th codes: Power rating.

E.g.: W=Normal Size “1~G” = “1~16”

Wattage	3/4	1/2	1/3	1/4	1/8	1.25	2
Normal Size	07	W2	W3	W4	W8	1Q	2W

If power rating is equal or lower than 1 watt, 5th code would be “W” and 6th code would be a number or letter.

E.g.: 07=3/4W W4=1/4W

2.3 7th code: Tolerance. E.g.: D=±0.5% F=±1% J=±5%

2.4 8th~11th codes: Resistance Value.

2.4.1 If value belongs to standard value of E-24 series, the 8th code is zero, 9th~10th codes are the significant figures of resistance value, and the 11th code is the power of ten.

2.4.2 If value belongs to standard value of E-96 series, the 8th~10th codes are the significant figures of resistance value, and the 11th code is the power of ten.

2.4.3 11th codes listed as following:

0=10⁰ 1=10¹ 2=10² 3=10³ 4=10⁴ 5=10⁵ 6=10⁶ J=10⁻¹ K=10⁻² L=10⁻³ M=10⁻⁴

2.5 12th~14th codes.

2.5.1 12th code: Packaging Type. E.g.: T=Tape/Reel

2.5.2 13th code: Standard Packing Quantity.

4=4,000pcs 5=5,000pcs C=10,000pcs

2.5.3 14th code: Special features.

E = Standard

3. Ordering Procedure

(Example: PS05 1/3W ±5% 10KΩ T/R-5000)

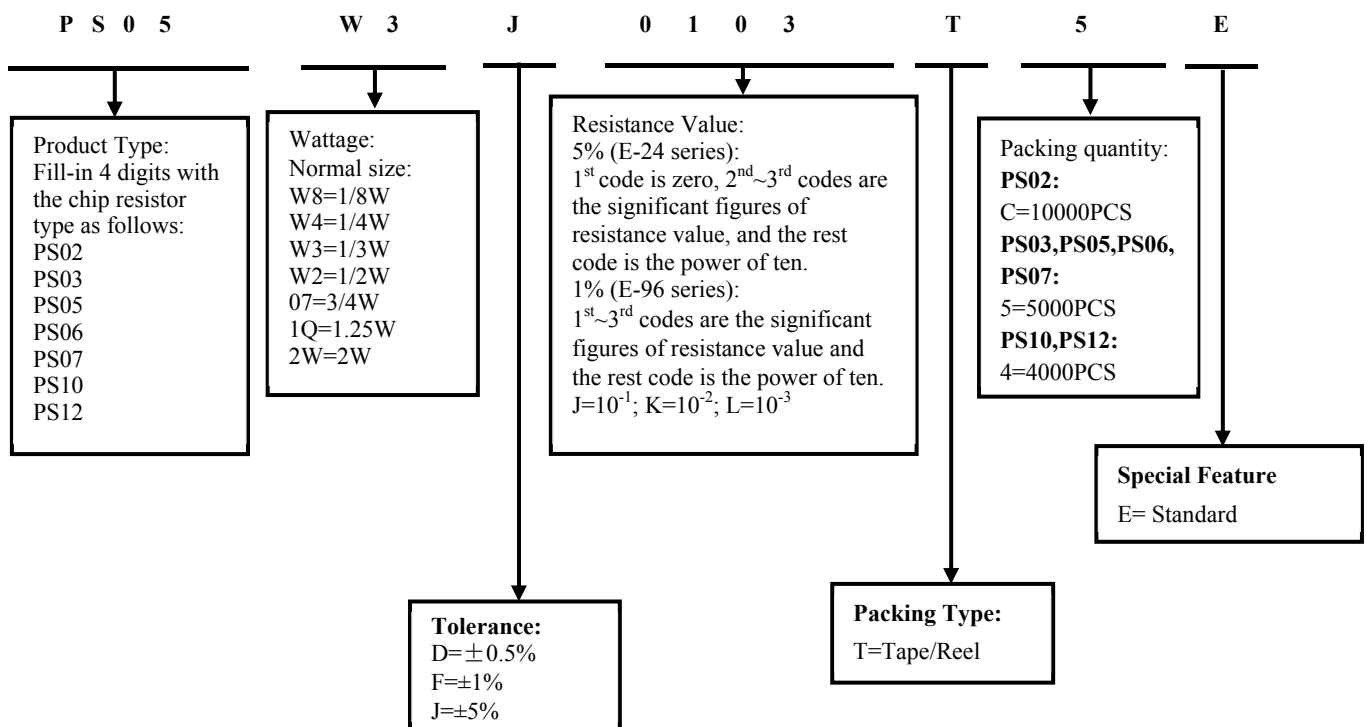

4. Marking

4.1 For PS02 size. Due to the very small size of the resistor's body, there is no marking on the body.



4.2 ±5% tolerance products (E-24 series):

3 codes.

1st~2nd codes are the significant figures of resistance value, and the rest code is the power of ten.



333 → 33KΩ

4.3 ±0.5%,±1% tolerance products (E-96 series):

4 codes.

1st~3rd codes are the significant figures of resistance value, and the rest code is the power of ten.

Letter "R" in mark means decimal point.



2701 → 2.7KΩ

4.4 Standard E-96 series values of PS03 ≤±1% : due to the small size of the resistor's body, 3 digits marking will be used to indicate the accurate resistance value by using the following multiplier & resistance code.

Multiplier Code (for PS03 ≤±1% marking)

Code	A	B	C	D	E	F	G	H	X	Y	Z
Multiplier	10 ⁰	10 ¹	10 ²	10 ³	10 ⁴	10 ⁵	10 ⁶	10 ⁷	10 ⁻¹	10 ⁻²	10 ⁻³

Standard E-96 series Resistance Value code (for PS03 ≤±1% marking)

Value	Code	Value	Code	Value	Code	Value	Code
100	01	178	25	316	49	562	73
102	02	182	26	324	50	576	74
105	03	187	27	332	51	590	75
107	04	191	28	340	52	604	76
110	05	196	29	348	53	619	77
113	06	200	30	357	54	634	78
115	07	205	31	365	55	649	79
118	08	210	32	374	56	665	80
121	09	215	33	383	57	681	81
124	10	221	34	392	58	698	82
127	11	226	35	402	59	715	83
130	12	232	36	412	60	732	84
133	13	237	37	422	61	750	85
137	14	243	38	432	62	768	86
140	15	249	39	442	63	787	87
143	16	255	40	453	64	806	88
147	17	261	41	464	65	825	89
150	18	267	42	475	66	845	90
154	19	274	43	487	67	866	91
158	20	280	44	499	68	887	92
162	21	287	45	511	69	909	93
165	22	294	46	523	70	931	94
169	23	301	47	536	71	953	95
174	24	309	48	549	72	976	96

So the resistance value are marked as the following examples



1.96KΩ=196×10¹Ω=29B



12.4Ω=124×10⁻¹Ω=10X

4.5 Standard E-24 and not belong to E-96 series values ($\leq \pm 1\%$) of PS03 size: the marking is the same as 5% tolerance but marking as underline.



333=33KΩ



680=68Ω

5. Ratings & Dimension

Type	Dimension(mm)				
	L	W	H	A	B
PS02(0402)	1.00±0.10	0.50±0.05	0.35±0.05	0.20±0.10	0.25±0.10
PS03(0603)	1.60±0.10	0.80±0.10	0.45±0.10	0.30±0.20	0.30±0.20
PS05(0805)	2.00±0.15	1.25±0.15/-0.10	0.55±0.10	0.40±0.20	0.40±0.20
PS06(1206)	3.10±0.15	1.55±0.15/-0.10	0.55±0.10	0.45±0.20	0.45±0.20
PS07(1210)	3.10±0.10	2.50±0.15	0.55±0.10	0.55±0.25	0.50±0.20
PS10(2010)	5.00±0.10	2.50±0.20	0.55±0.10	0.60±0.25	0.50±0.20
PS12(2512)	6.35±0.10	3.20±0.20	0.55±0.10	0.60±0.25	0.50±0.20

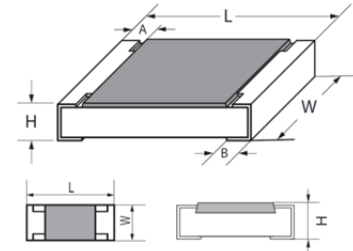

6. Resistance Range

Type	Power Rating	Resistance Range		
		±0.5%	±1.0%	±5.0%
PS02	1/8W	1Ω-10MΩ	1Ω-10MΩ	1Ω-10MΩ
PS03	1/4W	1Ω-10MΩ	1Ω-10MΩ	1Ω-10MΩ
PS05	1/3W	1Ω-10MΩ	1Ω-10MΩ	1Ω-10MΩ
PS06	1/2W	0.1Ω-10MΩ	0.1Ω-10MΩ	0.1Ω-10MΩ
PS07	3/4W	0.1Ω-10MΩ	0.1Ω-10MΩ	0.1Ω-10MΩ
PS10	1.25W	1Ω-10MΩ	1Ω-10MΩ	1Ω-10MΩ
PS12	2W	0.1Ω-10MΩ	0.1Ω-10MΩ	0.1Ω-10MΩ

7. Ratings

Type	Max Working Voltage	Max Overload Voltage	Dielectric Withstanding Voltage	Operating Temperature
PS02	50V	100V	100V	-55 ~ +155°C
PS03	75V	150V	300V	
PS05	150V	300V	500V	
PS06	200V	400V	500V	
PS07	200V	500V	500V	
PS10	400V	800V	500V	
PS12	500V	1000V	500V	

8. Soldering pad size recommended

Type	Dimension(mm)			
	A	B	C	D
PS02	0.5±0.05	0.5±0.05	0.6±0.05	1.5±0.05
PS03	0.8±0.05	0.8±0.05	0.9±0.05	2.4±0.05
PS05	1.0±0.1	1.0±0.1	1.4±0.1	3.0±0.1
PS06	2.0±0.1	1.1±0.1	1.8±0.1	4.2±0.1
PS07	2.0±0.1	1.1±0.1	2.9±0.1	4.2±0.1
PS10	3.6±0.1	1.4±0.1	3±0.1	6.4±0.1
PS12	4.9±0.1	1.35±0.1	3.7±0.1	7.6±0.1

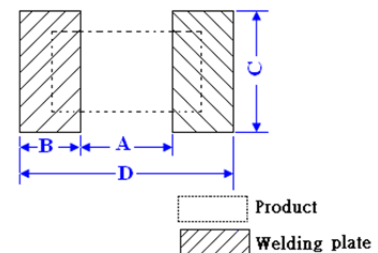

9. Derating Curve

Power rating will change based on continuous load at ambient temperature from -55 to 155°C. It is constant between -55 to 70°C, and derate to zero when temperature rise from 70 to 155°C.

Voltage rating:

Resistors shall have a rated direct-current (DC) continuous working voltage or an approximate sine-wave root-mean-square (RMS) alternating-current (AC) continuous working voltage at commercial-line frequency and waveform corresponding to the power rating, as determined from the following formula:

$$RCWV = \sqrt{P \times R}$$

Remark: RCWV: Rating Continuous Working Voltage (Volt.) P: power rating (Watt) R: nominal resistance (Ω)
In no case shall the rated DC or RMS AC continuous working voltage be greater than the applicable maximum value. The overload voltage is 2.5 times RCWV or Max. Overload voltage whichever is lower.

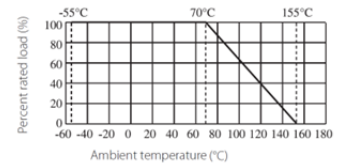

10. One-pulse Limiting Electric Power

10.1 Curve of Pulse Duration :

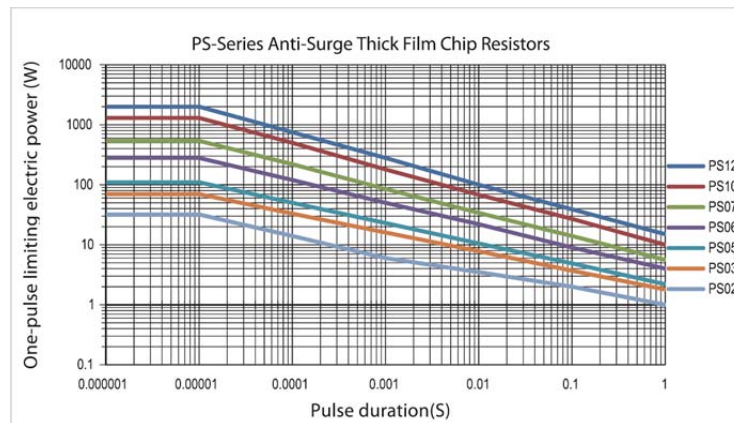

10.2 Pulse Voltage Limit :

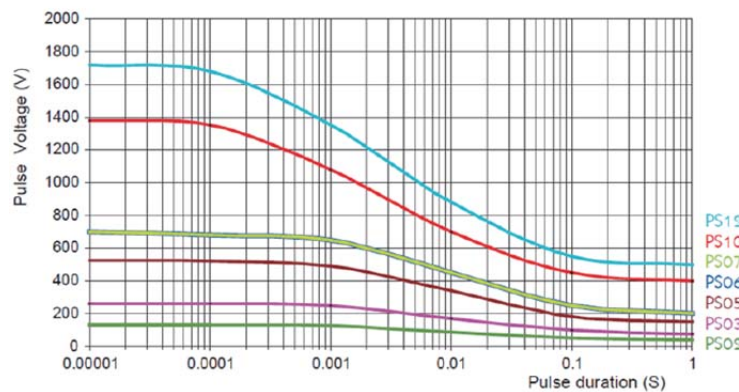

11. Structure

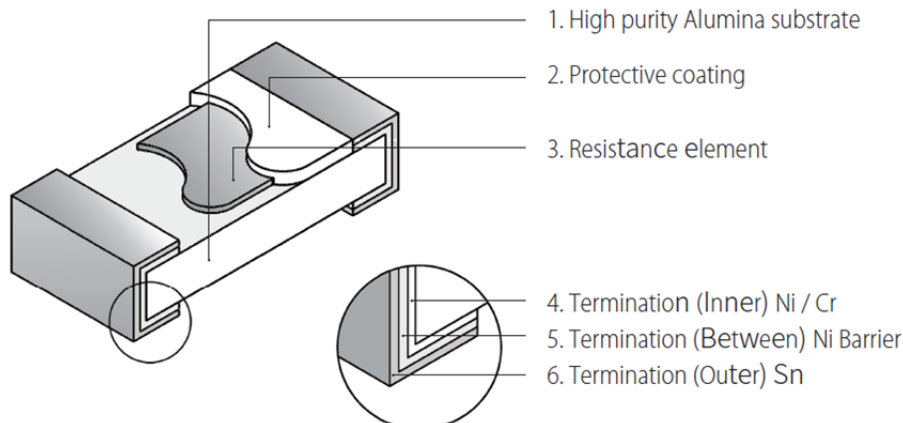

12. Performance Specification

Characteristic	Limits	Ref. Standards	Test Method
Operational life	$\pm 0.5\%, \pm 1\%: \pm(1\%+0.1\Omega)$ $\pm 5\%: \pm(3\%+0.1\Omega)$	MIL-STD-202 Method 108	125°C, at 36% of operating power, 1000H(1.5 hours "ON", 0.5 hour "OFF"). Measurement at 24±4 hours after test conclusion.
Electrical Characterization (T.C.R)	PS02: $1\Omega \leq R \leq 10\Omega: \pm 400\text{PPM}/^\circ\text{C}$ $10\Omega < R \leq 100\Omega: \pm 200\text{PPM}/^\circ\text{C}$ $> 100\Omega: \pm 100\text{PPM}/^\circ\text{C}$ PS03,PS05,PS06,PS07,PS10,PS12: $\pm 100\text{PPM}/^\circ\text{C}$	GB/T 5729 4.8 JIS-C-5201 4.8 IEC 60115-1 6.2	Natural resistance changes per temp. Degree centigrade $\frac{R_2-R_1}{R_1(t_2-t_1)} \times 10^6$ (PPM/°C) R ₁ : Resistance Value at room temperature (t ₁) ; R ₂ : Resistance at test temperature (t ₂) t ₁ : +25°C or specified room temperature t ₂ : Test temperature (-55°C or 125°C)
Short-time overload	$\pm 0.5\%, \pm 1\%: \pm(1.0\%+0.1\Omega)$ $\pm 5\%: \pm(2.0\%+0.1\Omega)$	GB/T 5729 4.13 JIS-C-5201 4.13 IEC 60115-1 8.1.4.2	4.13 Permanent resistance change after the application of a potential of 2.5 times RCWV or Max. Overload Voltage whichever less for 5 seconds..
External Visual	Marking Complete , no mechanical damage	MIL-STD-883 Method 2009	Electrical test not required. Inspect device construction, marking and workmanship
Physical Dimension	Reference 5.0 Dimension Standards	JESD22 MH Method JB-100	Verify physical dimensions to the applicable device detail specification. Note: User(s) and Suppliers spec. Electrical test not required.
Resistance to Solvent	Marking Complete , no mechanical damage	MIL-STD-202 Method 215	Note: Add Aqueous wash chemical – OKEM Clean or equivalent. Do not use banned solvents.
Terminal Strength	Not broken	AEC-Q200-006	PS02:5N; others:17.7N, 60±1 seconds.
High Temperature Exposure (Storage)	$\pm 0.5\%, \pm 1\%: \pm(1\%+0.1\Omega)$ $\pm 5\%: \pm(3\%+0.1\Omega)$	MIL-STD-202 Method 108	1000hrs. @T=155°C.Unpowered. Measurement at 24±4 hours after test conclusion.
Temperature Cycling	$\pm(1\%+0.1\Omega)$	JESD22 Method JA-104	1000 Cycles (-55°C to +155°C). Measurement at 24±4 hours after test conclusion.
Biased Humidity	$\pm 0.5\%, \pm 1\%: \pm(1\%+0.1\Omega)$ $\pm 5\%: \pm(3\%+0.1\Omega)$	MIL-STD-202 Method 103	1000 hours 85°C,85%RH. Note: Specified conditions: 10% of operating power. Measurement at 24±4 hours after test conclusion.
Mechanical Shock	$\pm 0.5\%, \pm 1\%: \pm(1\%+0.1\Omega)$ $\pm 5\%: \pm(2\%+0.1\Omega)$	MIL-STD-202 Method 213	Half sine wave, acceleration 100g's, each three times in X, Y and Z directions, pulse width 6ms.
Vibration	$\pm 0.5\%, \pm 1\%: \pm(1\%+0.1\Omega)$ $\pm 5\%: \pm(2\%+0.1\Omega)$	MIL-STD-202 Method 204	5g's for 20 min., 12cycle each of 3 orientations. Note: Use 8"×5"PCB. 031" thick 7 secure points on one long side and 2 secure points at corners of opposite sides. Parts mounted within 2" from any secure point. Test from 10-2000Hz.
ESD	$\pm(3.0\%+0.1\Omega)$	AEC-Q200-002	With the electrometer in direct contact with the discharge tip, verify the voltage setting at levels of ±500V,±1KV, ±2KV, ±4KV, ±8KV, The electrometer reading shall be within ±10% for voltages from 500V to ≅ 800V.
Solderability	95% coverage Min.	J-STD-002	For both leaded & SMD. Electrical test not required. Magnification 50X. Conditions: a) Method B 4hrs at 155°C dry heat, the dip in bath with 245±3°C, 5±0.5s. b) Method D: at 260±3°C, 30±0.5s.
Flammability	No ignition of the tissue paper or scorching or the pinewood board	UL-94	V-0 or V-1 are acceptable. Electrical test not required.
Board Flex	$\pm(1\%+0.05\Omega)$	AEC-Q200-005	Bending 2mm(min) for 60+5sec
Resistance to Soldering Heat	$\pm(1\%+0.05\Omega)$	MIL-STD-202 Method 210	Condition B No per-heat of samples. Dipping the resistor into a solder bath having a temperature of 260°C±5°C and hold it for 10±1 seconds
Flame Retardance	No flame	AEC-Q200-001	Only requested, when voltage/power will increase the surface temp to 350°C.Apply voltage from 9V to 32V. No flame; No explosion.

13. Soldering Condition

(This is for recommendation, please customer perform adjustment according to actual application)

13.1 Recommend Reflow Soldering Profile : (solder : Sn96.5 / Ag3 / Cu0.5)

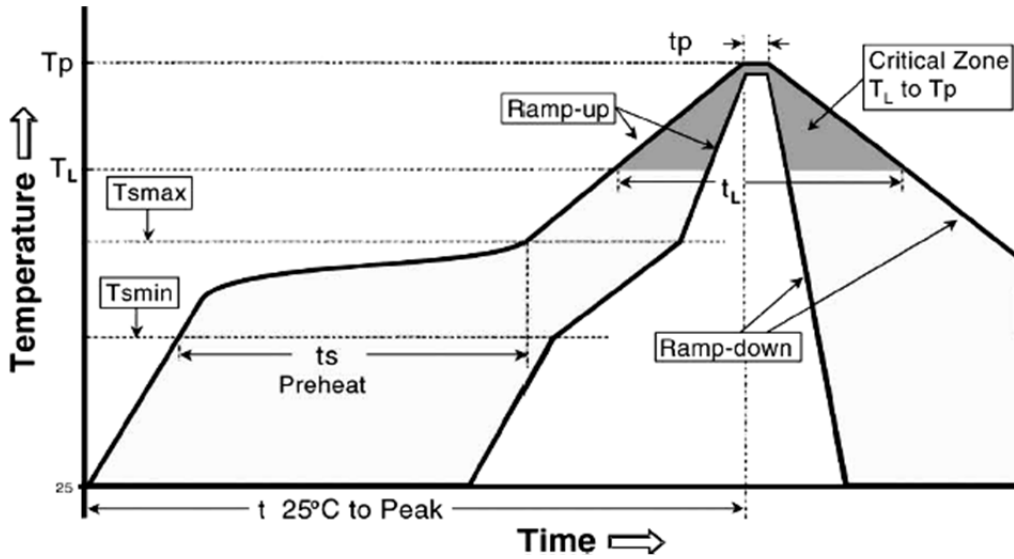

Profile Feature	Lead (Pb)-Free solder
Preheat: Temperature Min (T_{smin}) Temperature Max (T_{smax}) Time (T_{smin} to T_{smax}) (t_s)	150°C 200°C 60 -120 seconds
Average ramp-up rate : (T_{smax} to T_p)	3°C / second max.
Time maintained above : Temperature (T_L) Time (t_L)	217°C 60-150 seconds
Peak Temperature (T_p)	260°C
Time within $+0$ -5 °C of actual peak Temperature (t_p) ²	10 seconds
Ramp-down Rate	6°C/second max.
Time 25°C to Peak Temperature	8minutes max.

Allowed Re-flow times : 2 times

Remark : To avoid discoloration phenomena of chip on terminal electrodes, we suggest use N₂ Re-flow furnace .

13.2 Recommend Wave Soldering Profile : (Apply to 0603 and above size)

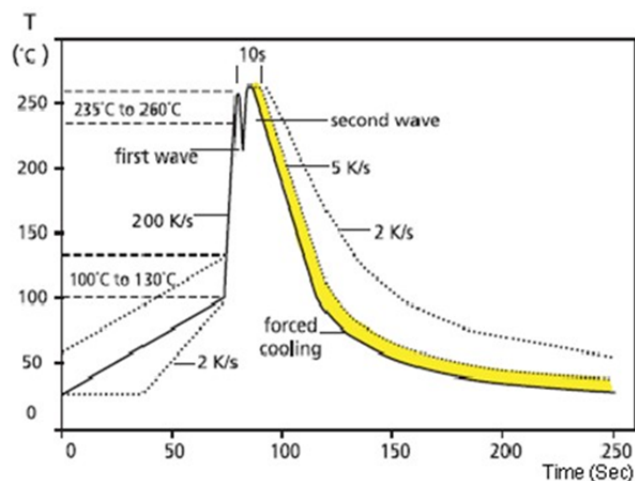

14. Packing

14.1 Dimension of Paper Taping : (Unit: mm)

Type	A ±0.1	B ±0.1	C ±0.05	$\Phi D_{-0}^{+0.1}$	E ±0.1	F ±0.05	G ±0.1	W ±0.2	T ±0.05
PS02	0.65	1.20	2.00	1.50	1.75	3.50	4.00	8.00	0.42

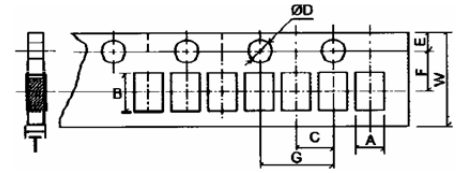

Type	A ±0.2	B ±0.2	C ±0.05	$\Phi D_{-0}^{+0.1}$	E ±0.1	F ±0.05	G ±0.1	W ±0.2	T ±0.10
PS03	1.10	1.90	2.00	1.50	1.75	3.50	4.00	8.00	0.67
PS05	1.65	2.40	2.00	1.50	1.75	3.50	4.00	8.00	0.81
PS06	2.00	3.60	2.00	1.50	1.75	3.50	4.00	8.00	0.81
PS07	2.80	3.50	2.00	1.50	1.75	3.50	4.00	8.00	0.75

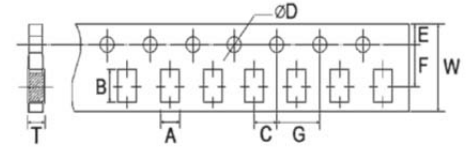

14.2 Dimension of plastic taping: (Unit: mm)

Type	A ±0.2	B ±0.2	C ±0.05	$\Phi D_{-0}^{+0.1}$	$\Phi D_{-0}^{+0.25}$	E ±0.1	F ±0.05	G ±0.1	W ±0.2	T ±0.1
PS10	2.90	5.60	2.00	1.50	1.50	1.75	5.50	4.00	12.00	1.00
PS12	3.50	6.70	2.00	1.50	1.50	1.75	5.50	4.00	12.00	1.00

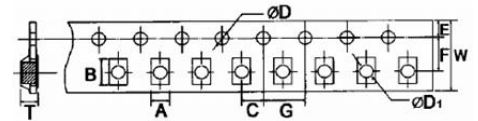

14.3 Dimension of Reel : (Unit: mm)

Type	Tape	Qty./Reel	A ±0.5	B ±0.5	C ±0.5	D ±1	L ±2	W ±1
PS02	Paper	10000pcs	2.0	13.0	21.0	60.0	178.0	10.0
PS03	Paper	5000pcs	2.0	13.0	21.0	60.0	178.0	10.0
PS05	Paper	5000pcs	2.0	13.0	21.0	60.0	178.0	10.0
PS06	Paper	5000pcs	2.0	13.0	21.0	60.0	178.0	10.0
PS07	Paper	5000pcs	2.0	13.0	21.0	60.0	178.0	10.0
PS10	Embossed	4000pcs	2.0	13.0	21.0	60.0	178.0	10.0
PS12	Embossed	4000pcs	2.0	13.0	21.0	60.0	178.0	10.0

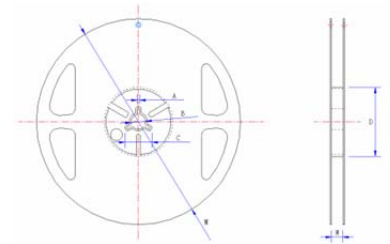

15. Note

- 15.1. UNI-ROYAL recommend products store in warehouse with temperature between 15 to 35°C under humidity between 25 to 75%RH.
Even under storage conditions recommended above, solder ability of products will be degraded stored over 1 year old.
- 15.2. Cartons must be placed in correct direction which indicated on carton, otherwise the reel or wire will be deformed.
- 15.3. Storage conditions as below are inappropriate:
 - a. Stored in high electrostatic environment
 - b. Stored in direct sunshine, rain, snow or condensation.
 - c. Exposed to sea wind or corrosive gases, such as Cl₂, H₂S, NH₃, SO₂, NO₂, Br etc.

16. Record

Version	Description	Page	Date	Amended by	Checked by
1	First version	1~8	May.25, 2020	Haiyan Chen	Yuhua Xu
2	1.Add 0603 Marking 2. Modify terminal strength test conditions	3~4 6	Sep.19, 2022	Haiyan Chen	Yuhua Xu
3	Modify Max Working Voltage and Max Overload Voltage of PS03	4	Jul.21, 2023	Fucong Liu	Haiyan Chen
4	Modify ESD test	6	Feb.19,2024	Song Nie	Haiyan Chen
5	Modify temperature cycling test	5	Aug.10, 2024	Haiyan Chen	Yuhua Xu
6	1.Add the ±0.5% tolerance 2. Modify the "W" dimension of PS07	2,4 4	Apr.17, 2025	Haiyan Chen	Yuhua Xu